

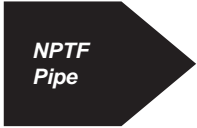

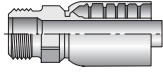







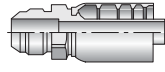
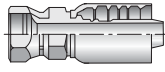
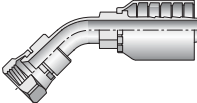
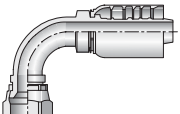

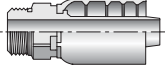

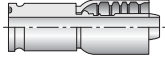
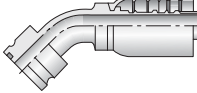
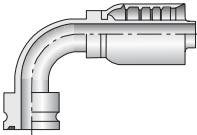

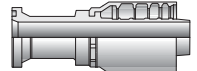
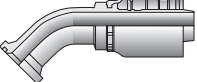
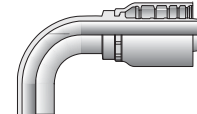
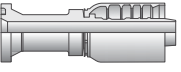
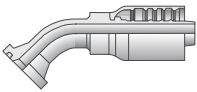
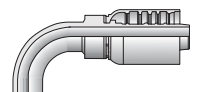

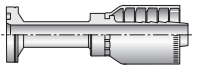
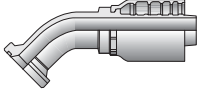
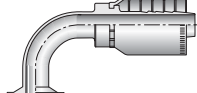

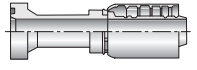
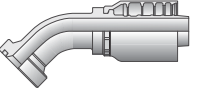
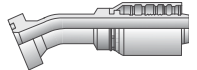
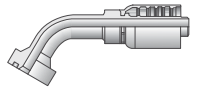
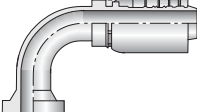

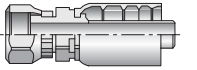
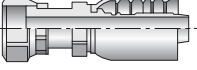
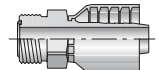
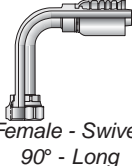
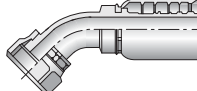
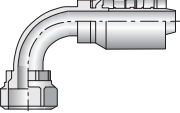
A	 NPTF Pipe	10177 B-97  Male - Rigid	 JIC 37°	10377 B-97  Male - Rigid	10677 B-97  Female - Swivel Straight	13777 B-98  Female - Swivel 45° Elbow - Short
	13977 B-98  Female - Swivel 90° Elbow - Short	 Straight Thread O-Ring	10577 B-97  Male - Rigid	 Full Flange	1X577 B-98  Full Flange - Straight	1X777 B-99  45° Elbow
1X977 B-99  90° Elbow	 Flange Code 61	14A77 B-100  Flange Code 61	14F77 B-100  Code 61 - 45° Elbow	14N77 B-101  Code 61 - 90° Elbow	11577 B-99  Flange Code 61	
11777 B-100  Flange Code 61	11977 B-100  Flange Code 61	 Flange Code 62	16A77 B-101  Flange Code 62	16F77 B-101  Code 62 45° Elbow	16N77 B-102  Code 62 90° Elbow	
 Caterpillar® Flange	1XA77 B-102  Caterpillar® - Flange	1XF77 B-102  Caterpillar® - Flange 45° Elbow	1XB77 B-103  Caterpillar® - Flange 22-1/2° Elbow	1XG77 B-103  Caterpillar® - Flange 60° Elbow	1XN77 B-103  Flange - 90° Elbow	
 Seal-Lok®	1JC77 B-104  Female - Swivel Straight - Short	1JS77 B-104  Female - Swivel Straight - Long	1J077 B-105  Male - Rigid w/O-Ring	1J177 B-105  Female - Swivel 90° - Long	1J777 B-105  Female - Swivel 45° Elbow	
1J977 B-106  Female - Swivel 90° Elbow - Short	 DIN "S" Series w/O-Ring	11C77 B-106  Female - Swivel 90° Elbow	1C977 B-106  Female - Swivel Straight	10C77 B-107  Female Metric S Swivel - 45° Elbow	1D277 B-107  Male Metric S Rigid - 24° Cone	
 BSP	1GU77 B-107  Female - Swivel Straight	 24° Cone	1ZM77 B-107  Male 20° Cone			

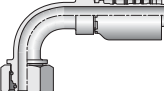
10177

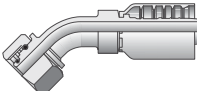
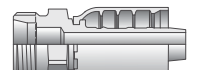
Male NPTF Pipe - Rigid - Straight

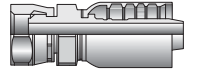
# Part Number	Thread inch	Hose I.D. inch	A		H mm	B	
			inch	mm		inch	mm
10177-8-8	1/2x14	1/2	2.72	69,2	22	1.50	38,2
10177-8-12	1/2x14	3/4	3.43	87,1	30	1.79	45,5
10177-12-12	3/4x14	3/4	3.43	87,1	30	1.79	45,5
10177-16-16	1x11-1/2	1	4.04	102,6	36	2.09	53,1
10177-20-20	1-1/4x11-1/2	1-1/4	4.57	116,1	46	2.30	58,4

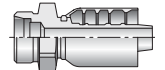
All sizes of 10177 fittings are rated at 5,000 psi working pressure.

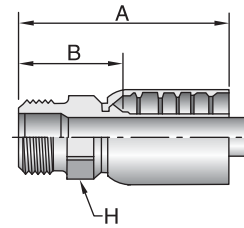

10377

Male JIC 37° - Rigid - Straight

# Part Number	Thread inch		Hose I.D. inch	A		H mm	B	
	inch	mm		inch	mm		inch	mm
10377-8-8	1/2	3/4x16	1/2	2.61	66,4	22	1.39	35,4
10377-10-8	5/8	7/8x14	1/2	2.71	68,9	24	1.49	37,9
10377-16-16	1	1-5/16x12	1	3.99	101,3	36	2.04	51,8

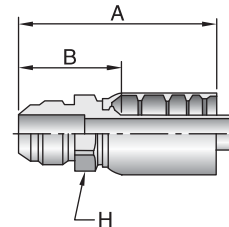

10577

Male SAE Straight Thread with O-Ring - Rigid - Straight

# Part Number	Thread inch		Hose I.D. inch	A		H inch	B	
	inch	mm		inch	mm		inch	mm
10577-8-8	1/2	3/4x16	1/2	2.39	60,8	22	1.17	29,8
10577-12-12	3/4	1-1/16x12	3/4	3.17	80,5	32	1.53	38,9
10577-16-16	1	1-5/16x12	1	3.73	94,7	41	1.78	45,2
10577-20-20	1-1/4	1-5/8x12	1-1/4	4.17	105,9	50	1.90	48,2

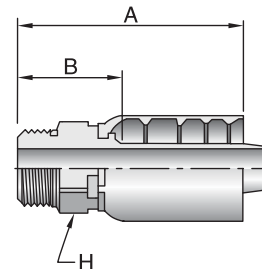

10677

Female JIC 37° - Swivel - Straight

# Part Number	Thread inch		Hose I.D. inch	A		H inch	W mm	B	
	inch	mm		inch	mm			inch	mm
10677-8-8	1/2	3/4x16	1/2	2.79	71,1	22	22	1.58	40,1
10677-10-8	5/8	7/8x14	1/2	2.91	74,0	22	27	1.69	43,0
10677-10-10	5/8	7/8x14	5/8	3.18	80,7	24	27	1.83	46,5
10677-12-10	3/4	1-1/16x12	5/8	3.30	83,9	30	32	1.95	49,6
10677-12-12	3/4	1-1/16x12	3/4	3.68	93,5	30	32	2.05	52,0
10677-16-12	1	1-5/16x12	3/4	3.89	98,7	36	41	2.25	57,3
10677-16-16	1	1-5/16x12	1	4.16	105,7	36	41	2.21	56,2
10677-20-16	1-1/4	1-5/8x12	1	4.29	109,1	41	50	2.34	59,5
10677-20-20	1-1/4	1-5/8x12	1-1/4	4.86	123,5	46	50	2.59	65,8

All sizes of 10677 fittings are rated at 5,000 psi working pressure.

⚠ Refer to Pressure Rating of Hose End Connections chart on page E-43.

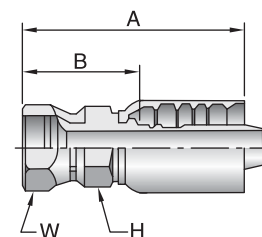

A

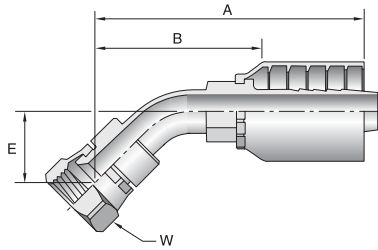

13777

Female JIC 37° - Swivel - 45° Elbow - Short Drop

# Part Number	Thread		Hose I.D. inch	A		E		W	B	
	inch	inch		inch	mm	inch	mm		inch	mm
13777-8-8	1/2	3/4x16	1/2	2.86	72,7	0.59	15	22	1.64	41,8
13777-12-12	3/4	1-1/16x12	3/4	4.37	110,9	0.83	21	32	2.73	69,4
13777-16-16	1	1-5/16x12	1	4.79	121,7	0.94	24	41	2.84	72,2
13777-20-20	1-1/4	1-5/8x12	1-1/4	6.03	153,2	1.26	32	50	3.76	95,5

All sizes of 13777 fittings are rated at 5,000 psi working pressure.

B

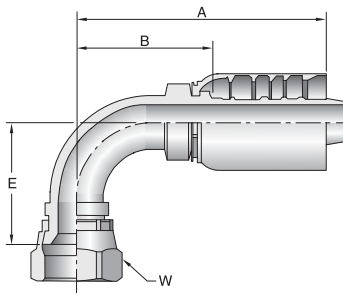

13977

Female JIC 37° - Swivel - 90° Elbow - Short Drop

# Part Number	Thread		Hose I.D. inch	A		E		W	B	
	inch	inch		inch	mm	inch	mm		inch	mm
13977-8-8	1/2	3/4x16	1/2	2.78	70,7	1.14	29,0	22	1.56	39,7
13977-12-12	3/4	1-1/16x12	3/4	4.23	107,4	1.89	48,0	32	2.60	66,0
13977-16-16	1	1-5/16x12	1	4.72	119,9	2.93	74,4	41	2.77	70,4
13977-20-20	1-1/4	1-5/8x12	1-1/4	5.81	147,6	3.07	78,0	50	3.54	90,0

All sizes of 13977 fittings are rated at 5,000 psi working pressure.

C

1X577

Full Flange - Straight - Code 61/62

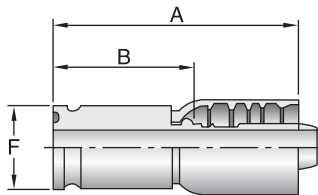

# Part Number	Flange inch	Hose I.D. inch	A		F	B	
			inch	mm		inch	mm
1X577-8-8	1/2	1/2	2.44	62,1	1.02	1.22	31,1
1X577-12-12	3/4	3/4	4.06	103,0	1.37	2.42	61,6
1X577-16-12	1	3/4	4.06	103,0	1.54	2.42	61,6
1X577-16-16	1	1	4.45	113,0	1.54	2.50	63,5
1X577-16-20	1	1-1/4	4.73	120,2	1.54	2.46	62,5
1X577-20-16	1-1/4	1	4.45	113,0	1.81	2.50	63,5
1X577-20-20	1-1/4	1-1/4	4.73	120,2	1.81	2.46	62,5
1X577-24-20	1-1/2	1-1/4	4.85	123,2	2.21	2.58	65,5

D

E

See Accessories Section for O-Rings and Flange Kits.

1X777

Full Flange - 45° Elbow - Code 61/62

# Part Number	Flange inch	Hose I.D. inch	A		E		F inch	B	
			inch	mm	inch	mm		inch	mm
1X777-12-12	3/4	3/4	4.67	118,5	1.12	28,5	1.37	3.03	77,0
1X777-16-12	1	3/4	4.66	118,3	1.12	28,5	1.54	3.02	76,8
1X777-16-16	1	1	5.11	129,8	1.26	32,0	1.54	3.16	80,3
1X777-16-20	1	1-1/4	5.74	145,8	1.50	38,0	1.54	3.47	88,1
1X777-20-16	1-1/4	1	5.35	135,9	1.50	38,0	1.81	3.40	86,4
1X777-20-20	1-1/4	1-1/4	6.27	159,3	1.50	38,0	1.81	4.00	101,6
1X777-24-20	1-1/2	1-1/4	6.51	165,4	1.73	44,0	2.21	4.24	107,7

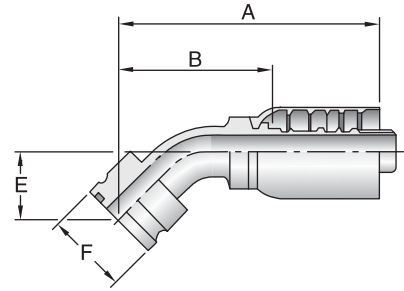

1X977

Full Flange - 90° Elbow - Code 61/62

# Part Number	Flange inch	Hose I.D. inch	A		E		F inch	B	
			inch	mm	inch	mm		inch	mm
1X977-8-8	1/2	1/2	3.14	79,8	1.69	43,0	1.02	1.92	48,9
1X977-12-12	3/4	3/4	4.24	107,6	2.38	60,5	1.37	2.60	66,1
1X977-16-12	1	3/4	4.24	107,6	2.38	60,5	1.54	2.60	66,1
1X977-12-16	3/4	1	4.33	109,9	2.76	70,0	1.37	2.38	60,5
1X977-16-16	1	1	4.73	120,1	2.76	70,0	1.54	2.78	70,6
1X977-16-20	1	1-1/4	5.12	130,1	3.54	90,0	1.54	2.85	72,4
1X977-20-16	1-1/4	1	4.73	120,1	2.76	70,0	1.81	2.78	70,6
1X977-20-20	1-1/4	1-1/4	5.81	147,6	3.54	90,0	1.81	3.54	90,0
1X977-24-20	1-1/2	1-1/4	5.81	147,6	3.54	90,0	2.21	3.54	90,0

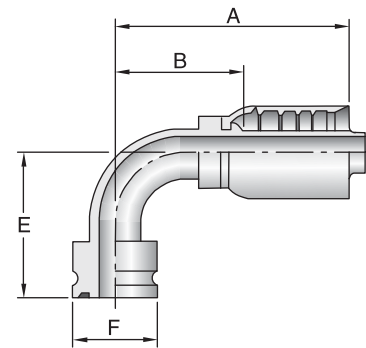

11577

SAE Code 61 Flange Head

ISO 12151-3-S-L

# Part Number	Flange inch	Hose I.D. inch	A		F inch	B	
			inch	mm		inch	mm
11577-8-8	1/2	1/2	3.52	89,6	1-3/16	2.30	58,6
11577-10-10	5/8	5/8	3.90	99,0	1-11/32	2.55	64,8
11577-12-12	3/4	3/4	4.23	107,4	1-1/2	2.59	65,9
11577-16-16	1	1	4.70	119,4	1-3/4	2.75	69,9

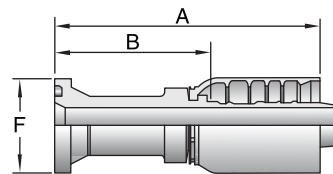

See Accessories Section for O-Rings and Flange Kits.

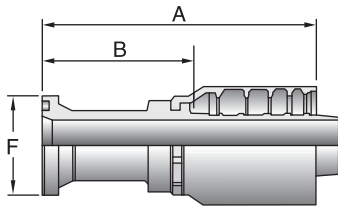

14A77

SAE Code 61 Flange Head - Straight

ISO 12151-3-S-L

# Part Number	Flange inch	Hose I.D. inch	A		F		B	
			inch	mm	inch	inch	mm	
14A77-20-20	1-1/4	1-1/4	5.42	137,7	2	3.15	80,0	
14A77-24-20	1-1/2	1-1/4	3.94	100,1	2-3/8	1.67	42,4	

11777

SAE Code 61 Flange Head - 45° Elbow

ISO 12151-3-E45S-L (1 Piece: ISO 12151-3-E45M-L)

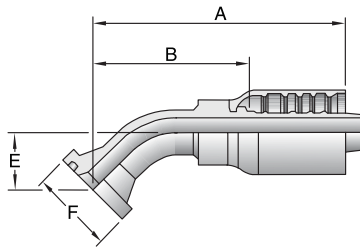

# Part Number	Flange inch	Hose I.D. inch	A		E		F		B	
			inch	mm	inch	mm	inch	inch	mm	
11777-8-8	1/2	1/2	3.11	79,0	0.79	20,0	1-3/16	1.89	48,0	
11777-12-12	3/4	3/4	4.57	116,0	1.02	26,0	1-1/2	2.93	74,5	
11777-16-16	1	1	5.11	129,8	1.26	32,0	1-3/4	3.16	80,3	

14F77

SAE Code 61 5000 psi Flange Head - 45°

ISO 12151-3 E45S-L (1 PIECE: ISO 12151-3-E45M-L)

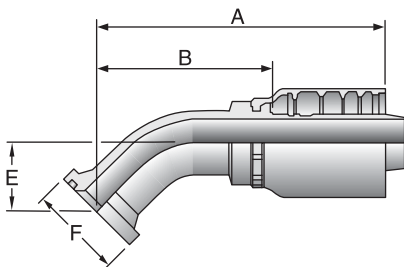

# Part Number	Flange inch	Hose I.D. inch	A		E		F		B	
			inch	mm	inch	mm	inch	inch	mm	
14F77-20-20	1-1/4	1-1/4	6.27	159,3	1.50	38	2	4.00	101,6	

11977

SAE Code 61 Flange Head - 90° Elbow

ISO 12151-3-E90S-L (1 Piece: ISO 12151-3-E90M-L)

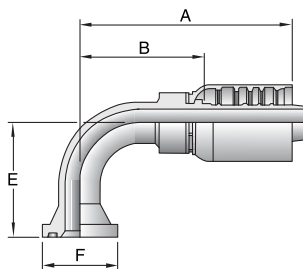

# Part Number	Flange inch	Hose I.D. inch	A		E		F		B	
			inch	mm	inch	mm	inch	inch	mm	
11977-8-8	1/2	1/2	2.99	76,0	1.61	41,0	1-3/16	1.77	45,0	
11977-12-12	3/4	3/4	4.24	107,6	2.28	58,0	1-1/2	2.60	66,1	
11977-16-16	1	1	4.72	119,9	2.76	70,0	1-3/4	2.77	70,4	

See Accessories Section for O-Rings and Flange Kits.

14N77

SAE Code 61 Flange Head - 90°

ISO 12151-3-E90S-L (1 PIECE: ISO 12151-3-E90M-L)

# Part Number	Flange inch	Hose I.D. inch	A		E		F inch	B	
			inch	mm	inch	mm		inch	mm
14N77-20-20	1-1/4	1-1/4	5.81	147,6	3.54	90	2	3.54	90,0

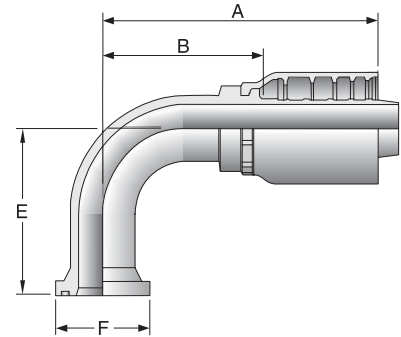

16A77

SAE Code 62 Flange Head - Straight

ISO 12151-3-S-S

# Part Number	Flange inch	Hose I.D. inch	A		F inch	B	
			inch	mm		inch	mm
16A77-12-10	3/4	5/8	2.95	74,9	1-5/8	1.60	40,7
16A77-12-12	3/4	3/4	4.49	113,9	1-5/8	2.85	72,5
16A77-16-12	1	3/4	3.47	88,1	1-7/8	1.83	46,6
16A77-16-16	1	1	5.26	133,6	1-7/8	3.31	84,1
16A77-20-16	1-1/4	1	4.05	102,9	2-1/8	2.10	53,4
16A77-20-20	1-1/4	1-1/4	5.73	145,6	2-1/8	3.46	87,8
16A77-24-20	1-1/2	1-1/4	4.65	118,1	2-1/2	2.38	60,4

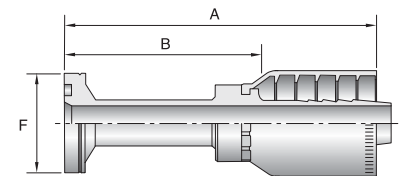

16F77

SAE Code 62 Flange Head - 45° Elbow

ISO 12151-3-E45S-S (1 PIECE: ISO 12151-3-E45M-S)

# Part Number	Flange inch	Hose I.D. inch	A		E		F inch	B	
			inch	mm	inch	mm		inch	mm
16F77-12-12	3/4	3/4	4.57	116,0	1.02	26	1-5/8	2.93	74,5
16F77-16-16	1	1	5.11	129,8	1.26	32	1-7/8	3.16	80,3
16F77-16-20	1	1-1/4	5.74	145,8	1.50	38	1-7/8	3.47	88,1
16F77-20-16	1-1/4	1	5.11	129,8	1.26	32	2-1/8	3.16	80,3
16F77-20-20	1-1/4	1-1/4	6.27	159,3	1.50	38	2-1/8	4.00	101,6
16F77-24-20	1-1/2	1-1/4	6.27	159,3	1.50	38	2-1/2	4.00	101,6

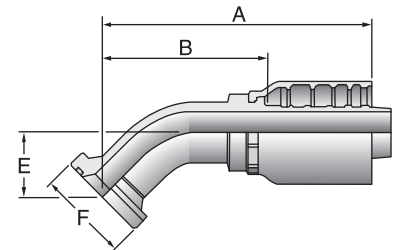





See Accessories Section for O-Rings and Flange Kits.

16N77

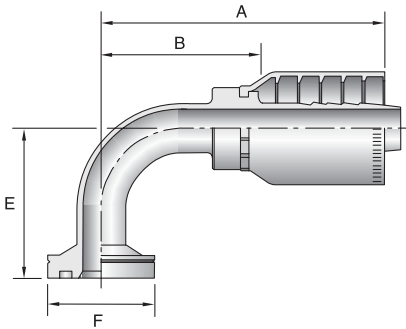
SAE Code 62 Flange Head - 90° Elbow

ISO 12151-3 - E90S - S (1 Piece: ISO 12151-3 - E90M - S)





#			A		E			B	
Part Number	Flange inch	Hose I.D. inch	inch	mm	inch	mm	inch	inch	mm
16N77-12-12	3/4	3/4	4.24	107,6	2.28	58	1-5/8	2.60	66,1
16N77-12-16	3/4	1	4.41	112,0	2.76	70	1-5/8	2.46	62,5
16N77-16-12	1	3/4	4.24	107,6	2.28	58	1-7/8	2.60	66,1
16N77-16-16	1	1	4.72	119,9	2.76	70	1-7/8	2.77	70,4
16N77-16-20	1	1-1/4	5.12	130,1	3.54	90	1-7/8	2.85	72,4
16N77-20-16	1-1/4	1	4.72	119,9	2.76	70	2-1/8	2.77	70,4
16N77-20-20	1-1/4	1-1/4	5.81	147,6	3.54	90	2-1/8	3.54	90,0
16N77-24-20	1-1/2	1-1/4	5.81	147,6	3.54	90	2-1/2	3.54	90,0

1XA77

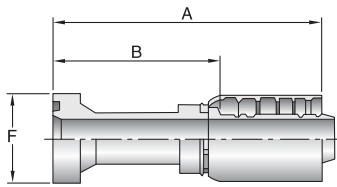
Caterpillar® Flange Head - Straight





#			A			B	
Part Number	Flange inch	Hose I.D. inch	inch	mm	inch	inch	mm
1XA77-12-12	3/4	3/4	4.48	113,7	1-5/8	2.84	72,2
1XA77-16-16	1	1	5.54	140,7	1-7/8	3.59	91,2
1XA77-20-16	1-1/4	1	4.10	104,1	2-1/8	2.15	54,6
1XA77-20-20	1-1/4	1-1/4	5.98	151,9	2-1/8	3.71	94,2

1XF77

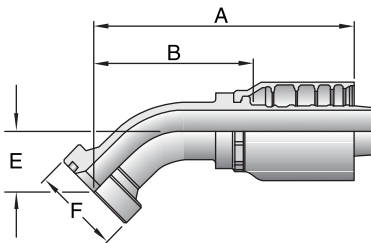
Caterpillar® Flange Head - 45° Elbow



#			A		E			B	
Part Number	Flange inch	Hose I.D. inch	inch	mm	inch	mm	inch	inch	mm
1XF77-12-12	3/4	3/4	4.57	116,0	1.22	31,0	1-5/8	2.93	74,5
1XF77-16-16	1	1	5.26	133,6	1.42	36,0	1-7/8	3.31	84,1
1XF77-20-16	1-1/4	1	5.26	133,6	1.42	36,0	2-1/8	3.31	84,1
1XF77-20-20	1-1/4	1-1/4	6.23	158,2	1.46	37,0	2-1/8	3.96	100,6
1XF77-24-20	1-1/2	1-1/4	6.23	158,2	1.46	37,0	2-1/2	3.96	100,6

See Accessories Section for O-Rings and Flange Kits.

1XB77

Caterpillar® Flange Head - 22-1/2° Elbow

# Part Number	Flange inch	Hose I.D. inch	A		E		F inch	B	
			inch	mm	inch	mm		inch	mm
1XB77-16-16	1	1	5.66	143,8	0.55	14,0	1-7/8	3.71	94,2
1XB77-20-20	1-1/4	1-1/4	6.60	167,7	0.58	14,7	2-1/8	4.33	109,9

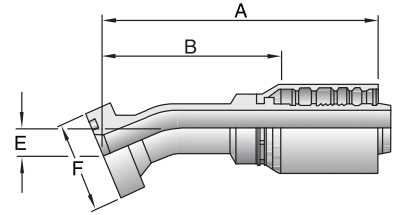

1XG77

Caterpillar® Flange Head - 60° Elbow

# Part Number	Flange inch	Hose I.D. inch	A		E		F inch	B	
			inch	mm	inch	mm		inch	mm
1XG77-12-12	3/4	3/4	5.35	135,8	1.65	42,0	1-5/8	3.71	94,3
1XG77-16-16	1	1	5.98	151,9	1.97	50,0	1-7/8	4.03	102,4
1XG77-20-20	1-1/4	1-1/4	7.74	196,6	2.01	51,0	2-1/8	5.47	138,9

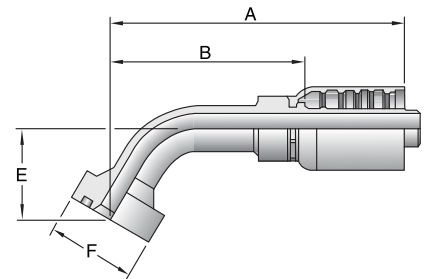

1XN77

Caterpillar® Flange Head - 90° Elbow

# Part Number	Flange inch	Hose I.D. inch	A		E		F inch	B	
			inch	mm	inch	mm		inch	mm
1XN77-12-12	3/4	3/4	4.23	107,4	2.48	63,0	1-5/8	2.59	65,9
1XN77-16-16	1	1	4.73	120,1	2.91	74,0	1-7/8	2.78	70,5
1XN77-20-16	1-1/4	1	4.73	120,1	2.91	74,0	2-1/8	2.78	70,5
1XN77-20-20	1-1/4	1-1/4	5.81	147,6	3.70	94,0	2-1/8	3.54	90,0
1XN77-24-20	1-1/2	1-1/4	5.81	147,6	3.03	77,0	2-1/2	3.54	90,0

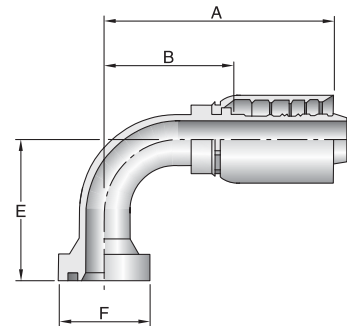

See Accessories Section for O-Rings and Flange Kits.

A

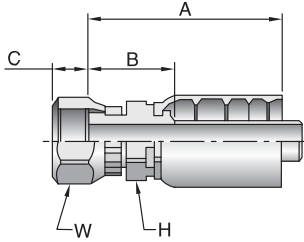

1JC77

Female Seal-Lok® - Swivel - Straight - Short
ISO 12151-1-SWSA

# Part Number	Thread inch	Hose I.D. inch	A		C		H		W	
			inch	mm	inch	mm	inch	inch	inch	mm
1JC77-8-8	1/2	13/16x16	2.35	59,8	0.43	11	22	24	1.13	28,8
1JC77-10-10	5/8	1x14	2.75	69,8	0.48	12	24	30	1.40	35,6

B

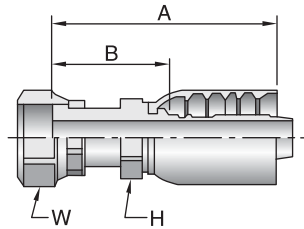

1JS77

Female Seal-Lok® - Swivel - Straight - Long
ISO 12151-1-SWSB

# Part Number	Thread inch	Hose I.D. inch	A		H		W		B	
			inch	mm	inch	inch	inch	mm		
1JS77-8-8	1/2	13/16x16	1/2	2.80	71,2	22	24	1.58	40,2	
1JS77-10-8	5/8	1x14	1/2	2.95	75,0	24	30	1.73	44,0	
1JS77-10-10	5/8	1x14	5/8	3.21	81,5	24	30	1.86	47,3	
1JS77-12-8	3/4	1-3/16x12	1/2	3.15	80,1	30	36	1.93	49,1	
1JS77-12-10	3/4	1-3/16x12	5/8	3.35	85,1	30	36	2.00	50,8	
1JS77-12-12	3/4	1-3/16x12	3/4	3.68	93,4	30	36	2.04	51,9	
1JS77-12-16	3/4	1-3/16x12	1	4.18	106,2	36	36	2.23	56,7	
1JS77-16-12	1	1-7/16x12	3/4	3.90	99,0	36	41	2.26	57,5	
1JS77-16-16	1	1-7/16x12	1	4.19	106,4	36	41	2.24	56,9	
1JS77-16-20	1	1-7/16x12	1-1/4	4.71	119,7	46	41	2.44	62,0	
1JS77-20-16	1-1/4	1-11/16x12	1	4.29	108,9	41	50	2.34	59,5	
1JS77-20-20	1-1/4	1-11/16x12	1-1/4	4.78	121,4	46	50	2.51	63,8	

C

D

E

See Accessories Section for O-Rings and Flange Kits.

1J077

Male Seal-Lok® - Rigid - Straight - (with O-Ring)

ISO 12151-1-S

# Part Number	Thread inch	Hose I.D. inch	A		H	B	
			inch	mm	mm	inch	mm
1J077-10-8	1x14	1/2	2.67	67,9	27	1.45	36,9
1J077-12-10	1-3/16x12	5/8	2.97	75,4	30	1.62	41,2
1J077-12-12	1-3/16x12	3/4	3.27	82,9	32	1.63	41,5
1J077-16-12	1-7/16x12	3/4	3.32	84,3	41	1.68	42,8
1J077-16-16	1-7/16x12	1	3.74	95,0	41	1.79	45,5
1J077-20-16	1-11/16x12	1	3.68	93,4	46	1.73	43,9

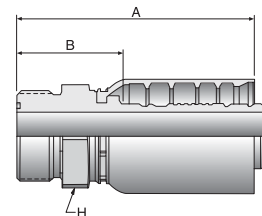

1J177

Female Seal-Lok® - Swivel - 90° Elbow - Long Drop

ISO 12151-1-SWEL90

# Part Number	Thread inch	Hose I.D. inch	A		E		W	B	
			inch	mm	inch	mm	mm	inch	mm
1J177-8-8	13/16x16	1/2	2.77	70,5	2.52	64	24	1.55	39,5
1J177-10-10	1x14	5/8	3.21	81,5	2.76	70	30	1.86	47,3
1J177-12-12	1-13/16x12	3/4	4.23	107,4	3.78	96	36	2.59	65,9
1J177-16-16	1-7/16x12	1	4.73	120,1	4.49	114	41	2.78	70,6

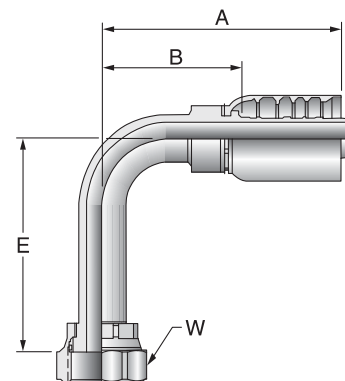

1J777

Female Seal-Lok® - Swivel - 45° Elbow

ISO 12151-1-SWE45

# Part Number	Thread inch		Hose I.D. inch	A		E		W	B	
	inch	mm		inch	mm	inch	mm	inch	mm	
1J777-8-8	1/2	13/16x16	1/2	2.86	72,7	0.59	15	24	1.64	41,8
1J777-10-10	5/8	1x14	5/8	3.28	83,3	0.63	16	30	1.93	49,0
1J777-12-12	3/4	1-3/16x12	3/4	4.39	111,4	0.83	21	36	2.75	69,9
1J777-16-16	1	1-7/16x12	1	4.79	121,7	0.94	24	41	2.84	72,2
1J777-20-20	1-1/4	1-11/16x12	1-1/4	5.69	144,6	0.98	25	50	3.42	86,8

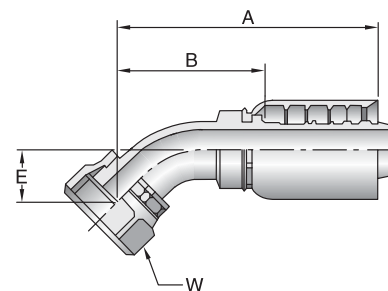

See Accessories Section for O-Rings and Flange Kits.

A

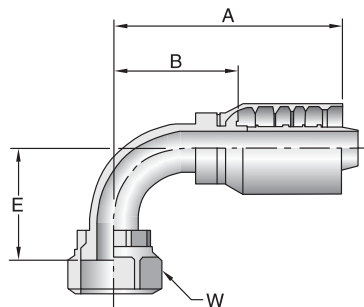

1J977

Female Seal-Lok® - Swivel - 90° Elbow - Short Drop
ISO 12151-1-SWES90

# Part Number	Thread inch	Hose I.D. inch	A		E		W mm	B		
			inch	mm	inch	mm		inch	mm	
1J977-8-8	1/2	13/16x16	1/2	2.78	70,7	1.14	29	24	1.56	39,7
1J977-10-10	5/8	1x14	5/8	3.21	81,5	1.26	32	30	1.86	47,3
1J977-12-12	3/4	1-3/16x12	3/4	4.23	107,5	1.89	48	36	2.60	66,0
1J977-16-16	1	1-7/16x12	1	4.73	120,1	2.20	56	41	2.78	70,6
1J977-16-20	1	1-7/16x12	1-1/4	5.12	130,1	2.20	56	41	2.85	72,4
1J977-20-20	1-1/4	1-11/16x12	1-1/4	5.73	145,5	2.52	64	50	3.46	87,9

B

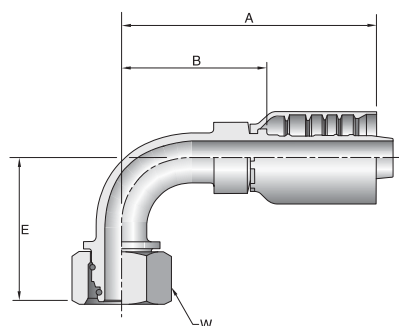

11C77

Female Metric S - Swivel - 90° Elbow - (24° Cone with O-Ring)
ISO 12151-2-SWE

# Part Number	Thread inch	Hose I.D. inch	A		E		W mm	B	
			inch	mm	inch	mm		inch	mm
11C77-16-8	M24x1,5	1/2	3.03	77	1.77	45	30	1.65	45
11C77-20-12	M30x2	3/4	4.25	108	2.36	60	36	2.44	62
11C77-25-12	M36x2	3/4	4.25	108	2.32	59	46	2.44	62
11C77-30-16	M42x2	1	5.16	131	2.72	69	50	3.03	77
11C77-38-20	M52x2	1-1/4	5.94	151	3.07	78	60	3.42	87

C

D

E

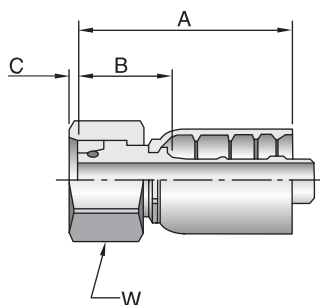

1C977

Female Metric S - Swivel - Straight (24° Cone with O-Ring)
ISO 12151-2-SWS

# Part Number	Thread mm	Hose I.D. inch	A		C		W mm	B		
			inch	mm	inch	mm		inch	mm	
1C977-16-8	16	M24x1,5	1/2	2.34	59,5	0.09	2,0	30	1.12	28,5
1C977-20-10	20	M30x2	5/8	2.64	67,0	0.05	1,0	36	1.29	32,8
1C977-20-12	20	M30x2	3/4	2.99	76,0	0.07	1,9	36	1.18	30,0
1C977-25-12	25	M36x2	3/4	3.00	76,5	0.10	3,0	46	1.37	35,0
1C977-30-16	30	M42x2	1	3.50	89,0	0.19	5,0	50	1.55	39,5
1C977-38-20	38	M52x2	1-1/4	3.86	98,0	0.27	6,9	60	1.38	35,0

When measuring overall length to end of nut, B + C dimensions must be used to calculate cut-off allowance.

See Accessories Section for O-Rings and Flange Kits.

10C77

Female Metric S - Swivel - 45° Elbow - (24° Cone with O-Ring)

ISO 12151-2-SWE-45

# Part Number	Thread mm	Hose I.D. inch	A		E		W inch	B	
			inch	mm	inch	mm		inch	mm
10C77-16-8	16 M24x1,5	1/2	3.26	82,9	0.93	23,5	30	2.04	51,9
10C77-20-10	20 M30x2	5/8	4.21	106,9	1.10	28,0	36	2.86	72,7
10C77-25-12	25 M36x2	3/4	4.69	119,0	1.14	29,0	46	3.05	77,6
10C77-30-16	30 M42x2	1	5.59	142,0	1.30	33,0	50	3.64	92,5
10C77-38-20	38 M52x2	1-1/4	6.33	160,8	1.44	36,5	60	4.06	103,1

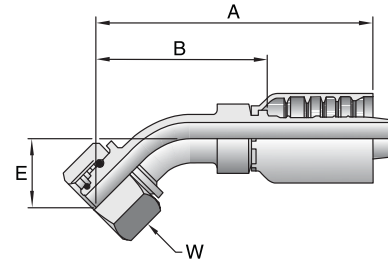

1D277

Male Metric S - Rigid - (24° Cone)

End Connection per ISO 8434-1-BHS

# Part Number	Thread mm	Hose I.D. inch	A		H mm	B	
			inch	mm		inch	mm
1D277-16-8	M24x1,5	1/2	2.53	64,4	24	1.31	33,4
1D277-20-10	M30x2	5/8	2.85	72,4	30	1.50	38,1
1D277-25-12	M36x2	3/4	3.39	86,3	36	1.76	44,8
1D277-30-16	M42x3	1	3.91	99,3	46	1.96	49,8
1D277-38-20	M52x2	1-1/4	4.50	114,3	55	2.23	56,6

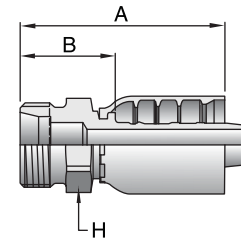

1GU77

Female BSP Parallel Pipe - Swivel - Straight (60° Cone)

# Part Number	Thread inch	Hose I.D. inch	A		H inch	W inch	B	
			inch	mm			inch	mm
1GU77-12-12	3/4x14	3/4	3.74	94,9	36	36	2.10	53,4
1GU77-16-16	1x11	1	4.33	110,0	41	41	2.38	60,5

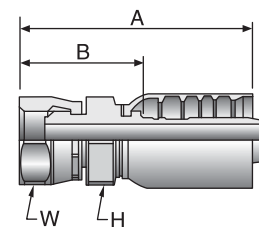

1ZM77

Male 24° Cone Metric - Rigid - Straight

# Part Number	Thread mm	Hose I.D. inch	A		H mm	B	
			inch	mm		inch	mm
1ZM77-22-10	M30x1,5	5/8	2.83	71,8	36	1.48	37,6
1ZM77-28-12	M36x1,5	3/4	3.38	85,8	41	1.74	44,3
1ZM77-28-16	M36x1,5	1	3.77	95,8	41	1.82	46,2
1ZM77-35-16	M45x1,5	1	3.85	97,8	50	1.90	48,3

