

Couplings & Equipment Selector Guide

| Series | Hose Application / Construction / Selector Guide | | Size Range (in) | Page No. |
|------------------------------------|--|---|-----------------|----------|
| S101CS | Crimp coupling | Male NPTF Pipe – Straight Rigid | 3/4 - 1 | 384 |
| S101HY | Crimp coupling | Male NPTF Pipe – Straight Rigid | 1/4 - 1-1/4 | 375 |
| S102HY | Crimp coupling | Female NPTF Pipe – Straight Rigid | 1/4 - 1 | 376 |
| S103HY | Crimp coupling | Male JIC 37° – Straight Rigid | 1/4 - 1 | 376 |
| S106HY | Crimp coupling | Female JIC 37° – Straight Swivel | 1/4 - 1-1/4 | 377 |
| S107HY | Crimp coupling | Female NPSM Pipe – Straight Swivel | 1/4 - 1/2 | 377 |
| S113HY | Crimp coupling | Male NPTF Pipe – Straight Swivel | 1/4 - 1 | 378 |
| S139HY | Crimp coupling | Female JIC 37° – Swivel 90° Elbow Short Drop | 1/4 - 1 | 378 |
| S1APWC | Crimp coupling, oil field | Male API – Straight Rigid | 2 | 380 |
| S101WC | Crimp coupling | Male NPTF Pipe – Straight Rigid | 2 | 381 |
| S106WC | Crimp coupling | Female JIC 37° – Straight Swivel | 2 | 381 |
| S10143 | Crimp coupling | Male NPTF Pipe – Straight Rigid | 1/4 - 2 | 379 |
| S10643 | Crimp coupling | Female JIC 37° – Straight Swivel | 1/4 - 2 | 379 |
| S11343 | Crimp coupling | Male NPTF Pipe – Straight Swivel | 1/4 - 1/2 | 380 |
| S10171 | Crimp coupling | Male NPTF Pipe – Straight Rigid | 1-1/4 - 2 | 380 |
| S20820 | Reattachable coupling | Female SAE 45° – Straight Swivel | 5/16 | 386 |
| 7610/CS | Crimp coupling, steam | Female Ground Joint NPSM with Wing Nut and O-Ring | 3/4 - 1 | 385 |
| 7612 | Spud adapter, steam | 3/4" Female Pipe x 1-1/2" Ground Joint Male | | 385 |
| 7661/LA-FJ | Crimp coupling | Female JIC 37° – Straight Swivel | 1 | 383 |
| 7661/LA-NP | Crimp coupling | Male NPTF Pipe – Straight Rigid | 1 | 383 |
| 7661/LAR-FJ | Crimp coupling | Female JIC 37° – Straight Swivel with Internal O-Ring | 1 | 384 |
| 7661/LAR-MP | Crimp coupling | Male NPTF Pipe – Straight Rigid with Internal O-Ring | 1 | 384 |
| 7661/TY-FA | Crimp coupling | Female SAE 45° – Straight Swivel | 1/4, 5/8 | 381 |
| 7661/TY-FF | Crimp coupling | Female NPTF Pipe – Straight Rigid | 1/4 | 382 |
| 7661/TY-FJ | Crimp coupling | Female JIC 37° – Straight Swivel | 1/4, 1/2 | 382 |
| 7661/TY-MP | Crimp coupling | Male NPTF Pipe – Straight Rigid | 1/4, 1/2 | 382 |
| 7661/TY-SP | Crimp coupling | Male NPTF Pipe – Straight Swivel | 1/2 | 383 |
| CGHBL | Brass stem | Welding connection | 3/4 | 386 |
| HBL-C | Crimp coupling stem, DEF | Male NPTF Pipe – Straight Rigid (SS) | 3/4 | 385 |
| HBL-C | Crimp coupling stem, DEF | Male BSPP w/Seal – Straight Rigid (SS) | 3/4 | 385 |
| SMCP | Crimp ferrules, DEF | Nickel-Plated Brass | 3/4 | 386 |
| 1000, 2100, 3100, 4100, 4500, 5100 | Composite hose factory couplings | Aluminum, carbon steel, stainless steel | 1 - 10 | 387 |
| COS-K1 | Adjustable crimper | 1-1/4" ID hose capacity | | 388 |
| COS-K2 | Adjustable crimper | 2" ID hose capacity | | 389 |
| COS-K4 | Adjustable crimper | 4" ID hose capacity | | 390 |
| 660-T | Ferrule vise crimper, manual | 1" ID hose capacity | | 392 |
| 670-T | Ferrule vise crimper, air powered | 1" ID hose capacity | | 392 |

NOTE: This is a guide only. It is the responsibility of the end user to select and/or test the most appropriate product for the application. Refer to product pages for specific data. Contact Parker for additional information.

See pages ii through iv for an index of all product series by series number and pages v through xv for an index by application and by series name. Refer to pages 9-10 for a complete listing of industry standards.

Due to continual product improvements, Parker reserves the right to alter specifications without prior notice.



Series HY

S101HY Male NPTF Pipe – Straight Rigid

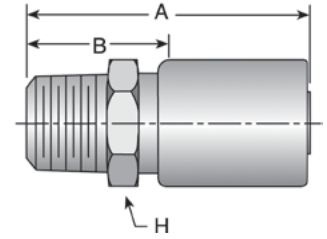

| Part Number | Hose ID (in) | Thread ID (in) | Thread Dash Size | Dimensions | | | | | Std Pack Qty (per carton) | Approx Wt Per Ctn (lbs) | Stock Status ** |
|--------------|--------------|----------------|------------------|------------|--------|--------|--------|--------|---------------------------|-------------------------|-----------------|
| | | | | A (in) | A (mm) | H (in) | B (in) | B (mm) | | | |
| S101HY-2-4 | 1/4 | 1/8x27 | -2 | 2.34 | 59 | 5/8 | 1.00 | 25 | 20 | 1.94 | Y |
| S101HY-4-4 | 1/4 | 1/4x18 | -4 | 2.53 | 64 | 9/16 | 1.19 | 30 | 25 | 2.73 | Y |
| S101HY-4-6 | 3/8 | 1/4x18 | -4 | 2.55 | 65 | 11/16 | 1.19 | 30 | 20 | 3.06 | Y |
| S101HY-6-4 | 1/4 | 3/8x18 | -6 | 2.53 | 64 | 3/4 | 1.19 | 30 | 20 | 2.68 | Y |
| S101HY-6-6 | 3/8 | 3/8x18 | -6 | 2.55 | 65 | 3/4 | 1.19 | 30 | 25 | 4.20 | Y |
| S101HY-6-8 | 1/2 | 3/8x18 | -6 | 2.72 | 69 | 7/8 | 1.38 | 35 | 20 | 4.54 | Y |
| S101HY-8-6 | 3/8 | 1/2x14 | -8 | 2.73 | 69 | 7/8 | 1.38 | 35 | 20 | 4.36 | Y |
| S101HY-8-8 | 1/2 | 1/2x14 | -8 | 2.91 | 74 | 7/8 | 1.41 | 40 | 25 | 6.53 | Y |
| S101HY-8-10 | 5/8 | 1/2x14 | -8 | 2.94 | 75 | 1-1/8 | 1.59 | 40 | 20 | 7.26 | N |
| S101HY-8-12 | 3/4 | 1/2x14 | -8 | 3.08 | 78 | 1-1/4 | 1.50 | 38 | 10 | 4.33 | Y |
| S101HY-12-8 | 1/2 | 3/4x14 | -12 | 2.91 | 74 | 1-1/16 | 1.56 | 40 | 20 | 7.60 | Y |
| S101HY-12-10 | 5/8 | 3/4x14 | -12 | 2.98 | 76 | 1-1/8 | 1.59 | 40 | 10 | 3.80 | N |
| S101HY-12-12 | 3/4 | 3/4x14 | -12 | 3.08 | 78 | 1-1/4 | 1.50 | 38 | 10 | 4.58 | Y |
| S101HY-12-16 | 1 | 3/4x14 | -12 | 3.23 | 82 | 1-3/8 | 1.63 | 41 | 10 | 5.40 | N |
| S101HY-16-12 | 3/4 | 1x11-1/2 | -16 | 3.27 | 83 | 1-3/8 | 1.69 | 43 | 10 | 5.10 | Y |
| S101HY-16-16 | 1 | 1x11-1/2 | -16 | 3.42 | 87 | 1-3/8 | 1.81 | 46 | 10 | 6.29 | Y |
| S101HY-20-20 | 1-1/4 | 1-1/4 x 11-1/2 | -20 | 3.84 | 98 | 1-3/4 | 2.00 | 51 | 4 | 6.62 | Y |

** Stock: "Y" indicates stocked item; "N" indicates non-stocked item. Stock status subject to change. Contact Parker Customer Service.

Couplings: Refer to CrimpSource at www.safehose.com for coupling recommendations and crimp specifications.

Series HY S102HY Female NPTF Pipe – Straight Rigid

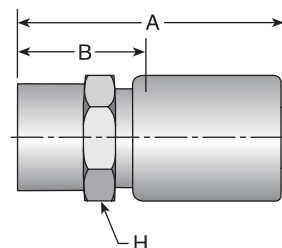

| Part Number | Hose ID (in) | Thread ID (in) | Thread Dash Size | Dimensions | | | | | Std Pack Qty (per carton) | Approx Wt Per Ctn (lbs) | Stock Status ** |
|--------------|--------------|----------------|------------------|------------|--------|--------|--------|--------|---------------------------|-------------------------|-----------------|
| | | | | A (in) | A (mm) | H (in) | B (in) | B (mm) | | | |
| S102HY-2-4 | 1/4 | 1/8x27 | -2 | 2.34 | 59 | 5/8 | 1.00 | 25 | 20 | 2.24 | N |
| S102HY-4-4 | 1/4 | 1/4x18 | -4 | 2.47 | 63 | 11/16 | 1.13 | 29 | 25 | 3.23 | Y |
| S102HY-4-6 | 3/8 | 1/4x18 | -4 | 2.48 | 63 | 11/16 | 1.13 | 29 | 20 | 2.94 | N |
| S102HY-6-4 | 1/4 | 3/8x18 | -6 | 2.47 | 63 | 7/8 | 1.13 | 29 | 20 | 2.94 | N |
| S102HY-6-6 | 3/8 | 3/8x18 | -6 | 2.48 | 63 | 7/8 | 1.13 | 29 | 25 | 4.58 | N |
| S102HY-8-6 | 3/8 | 1/2x14 | -8 | 2.75 | 70 | 1 | 1.41 | 36 | 25 | 5.53 | N |
| S102HY-8-8 | 1/2 | 1/2x14 | -8 | 2.84 | 72 | 1 | 1.50 | 38 | 25 | 6.98 | N |
| S102HY-12-12 | 3/4 | 3/4x14 | -12 | 2.83 | 72 | 1-1/4 | 1.25 | 32 | 10 | 4.05 | N |
| S102HY-16-16 | 1 | 1x11-1/2 | -16 | 3.27 | 83 | 1-1/2 | 1.66 | 42 | 10 | 6.18 | N |

** Stock: "Y" indicates stocked item; "N" indicates non-stocked item. Stock status subject to change. Contact Parker Customer Service.

Series HY S103HY Male JIC 37° – Straight Rigid

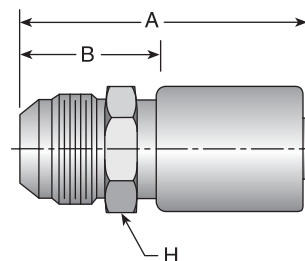

| Part Number | Hose ID (in) | Thread ID (in) | Thread Dash Size | Dimensions | | | | | Std Pack Qty (per carton) | Approx Wt Per Ctn (lbs) | Stock Status ** |
|--------------|--------------|----------------|------------------|------------|--------|--------|--------|--------|---------------------------|-------------------------|-----------------|
| | | | | A (in) | A (mm) | H (in) | B (in) | B (mm) | | | |
| S103HY-4-4 | 1/4 | 7/16x20 | -4 | 2.52 | 64 | 5/8 | 1.19 | 30 | 25 | 2.75 | Y |
| S103HY-6-4 | 1/4 | 9/16x18 | -6 | 2.53 | 64 | 11/16 | 1.19 | 30 | 20 | 2.68 | Y |
| S103HY-6-6 | 3/8 | 9/16x18 | -6 | 2.54 | 65 | 11/16 | 1.19 | 30 | 25 | 3.80 | Y |
| S103HY-6-8 | 1/2 | 9/16x18 | -6 | 2.72 | 69 | 7/8 | 1.38 | 35 | 25 | 5.50 | N |
| S103HY-8-6 | 3/8 | 3/4x16 | -8 | 2.64 | 67 | 13/16 | 1.28 | 33 | 20 | 3.96 | Y |
| S103HY-8-8 | 1/2 | 3/4x16 | -8 | 2.81 | 71 | 5/8 | 1.47 | 37 | 25 | 6.10 | Y |
| S103HY-10-8 | 1/2 | 7/8x14 | -10 | 2.91 | 74 | 1 | 1.56 | 40 | 20 | 5.60 | Y |
| S103HY-10-10 | 5/8 | 7/8x14 | -10 | 2.98 | 76 | 1-1/8 | 1.59 | 40 | 25 | 9.08 | N |
| S103HY-10-12 | 3/4 | 7/8x14 | -10 | 3.08 | 78 | 1-1/4 | 1.50 | 38 | 5 | 2.23 | N |
| S103HY-12-8 | 1/2 | 1-1/16x12 | -12 | 3.02 | 77 | 1-1/8 | 1.66 | 42 | 25 | 8.98 | N |
| S103HY-12-10 | 5/8 | 1-1/16x12 | -12 | 3.09 | 78 | 1-1/8 | 1.72 | 44 | 25 | 9.65 | N |
| S103HY-12-12 | 3/4 | 1-1/16x12 | -12 | 3.19 | 81 | 1-1/4 | 1.63 | 41 | 10 | 4.60 | Y |
| S103HY-16-12 | 3/4 | 1-5/16x12 | -16 | 3.23 | 82 | 1-3/8 | 1.66 | 42 | 10 | 5.29 | N |
| S103HY-16-16 | 1 | 1-5/16x12 | -16 | 3.39 | 86 | 1-3/8 | 1.78 | 45 | 10 | 6.44 | N |

** Stock: "Y" indicates stocked item; "N" indicates non-stocked item. Stock status subject to change. Contact Parker Customer Service.

Couplings: Refer to CrimpSource at www.safehose.com for coupling recommendations and crimp specifications.



Series HY

S106HY Female JIC 37° – Straight Swivel

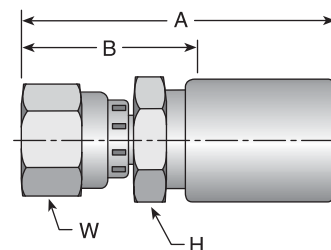

| Part Number | Hose ID (in) | Thread ID (in) | Thread Dash Size | Dimensions | | | | | | Std Pack Qty (per carton) | Approx Wt Per Ctn (lbs) | Stock Status ** |
|--------------|--------------|----------------|------------------|------------|--------|--------|--------|--------|--------|---------------------------|-------------------------|-----------------|
| | | | | A (in) | A (mm) | H (in) | W (in) | B (in) | B (mm) | | | |
| S106HY-4-4 | 1/4 | 7/16x20 | -4 | 2.60 | 66 | 9/16 | 9/16 | 1.25 | 32 | 25 | 3.18 | Y |
| S106HY-4-6 | 3/8 | 7/16x20 | -4 | 2.67 | 68 | 3/4 | 9/16 | 1.31 | 33 | 20 | 3.30 | Y |
| S106HY-5-4 | 1/4 | 1/2x20 | -5 | 2.65 | 67 | 9/16 | 5/8 | 1.31 | 33 | 20 | 2.52 | Y |
| S106HY-6-4 | 1/4 | 9/16x18 | -6 | 2.67 | 68 | 5/8 | 11/16 | 1.31 | 33 | 20 | 2.62 | Y |
| S106HY-6-6 | 3/8 | 9/16x18 | -6 | 2.69 | 68 | 11/16 | 11/16 | 1.34 | 34 | 50 | 8.35 | Y |
| S106HY-6-8 | 1/2 | 9/16x18 | -6 | 2.86 | 73 | 7/8 | 9/16 | 1.50 | 38 | 20 | 4.80 | N |
| S106HY-8-6 | 3/8 | 3/4x16 | -8 | 2.72 | 69 | 7/8 | 7/8 | 1.38 | 35 | 20 | 3.96 | Y |
| S106HY-8-8 | 1/2 | 3/4x16 | -8 | 2.90 | 74 | 7/8 | 7/8 | 1.56 | 40 | 50 | 13.20 | Y |
| S106HY-8-10 | 5/8 | 3/4x16 | -8 | 2.98 | 76 | 1-1/8 | 7/8 | 1.59 | 40 | 20 | 7.06 | N |
| S106HY-8-12 | 3/4 | 3/4x16 | -8 | 3.08 | 78 | 1-1/4 | 7/8 | 1.53 | 39 | 10 | 2.64 | N |
| S106HY-10-8 | 1/2 | 7/8x14 | -10 | 2.98 | 76 | 1 | 1 | 1.63 | 41 | 20 | 6.20 | Y |
| S106HY-10-10 | 5/8 | 7/8x14 | -10 | 3.06 | 78 | 1-1/8 | 1 | 1.69 | 43 | 25 | 9.95 | Y |
| S106HY-10-12 | 3/4 | 7/8x14 | -10 | 3.16 | 80 | 1-1/4 | 1 | 1.59 | 40 | 10 | 5.23 | N |
| S106HY-12-8 | 1/2 | 1-1/16x12 | -12 | 3.05 | 77 | 1-1/8 | 1-1/4 | 1.69 | 43 | 10 | 3.84 | Y |
| S106HY-12-10 | 5/8 | 1-1/16x12 | -12 | 3.12 | 79 | 1-1/8 | 1-1/4 | 1.75 | 44 | 10 | 4.48 | Y |
| S106HY-12-12 | 3/4 | 1-1/16x12 | -12 | 3.22 | 82 | 1-1/4 | 1-1/4 | 1.66 | 42 | 25 | 13.08 | Y |
| S106HY-12-16 | 1 | 1-1/16x12 | -12 | 3.38 | 86 | 1-3/8 | 1-1/4 | 1.75 | 44 | 10 | 6.40 | N |
| S106HY-16-16 | 1 | 1-5/16x12 | -16 | 3.45 | 88 | 1-3/8 | 1-1/2 | 1.84 | 47 | 10 | 6.86 | Y |
| S106HY-20-20 | 1-1/4 | 1-5/8x12 | -20 | 4.09 | 104 | 2 | 2 | 2.25 | 57 | 4 | 5.00 | Y |

** Stock: "Y" indicates stocked item; "N" indicates non-stocked item. Stock status subject to change. Contact Parker Customer Service.

Series HY

S107HY Female NPSM Pipe – Straight Swivel

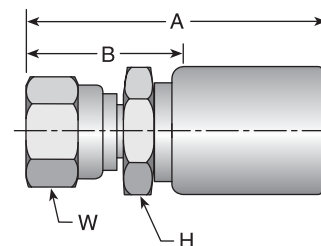

| Part Number | Hose ID (in) | Thread ID (in) | Thread Dash Size | Dimensions | | | | | | Std Pack Qty (per carton) | Approx Wt Per Ctn (lbs) | Stock Status ** |
|-------------|--------------|----------------|------------------|------------|--------|--------|--------|--------|--------|---------------------------|-------------------------|-----------------|
| | | | | A (in) | A (mm) | H (in) | W (in) | B (in) | B (mm) | | | |
| S107HY-4-4 | 1/4 | 1/4x18 | -4 | 2.66 | 68 | 9/16 | 11/16 | 1.31 | 33 | 20 | 2.76 | N |
| S107HY-6-6 | 3/8 | 3/8x18 | -6 | 2.55 | 65 | 3/4 | 7/8 | 1.19 | 30 | 25 | 5.25 | Y |
| S107HY-8-8 | 1/2 | 1/2x14 | -8 | 2.91 | 74 | 3/4 | 1 | 1.56 | 40 | 25 | 7.55 | N |

** Stock: "Y" indicates stocked item; "N" indicates non-stocked item. Stock status subject to change. Contact Parker Customer Service.

Couplings: Refer to CrimpSource at www.safehose.com for coupling recommendations and crimp specifications.

Parker Industrial Hose Customer Service
 866 810 HOSE (4673) 800 242 HOSE (4673)
 Strongsville, OH South Gate, CA
 Eastern USA Western USA

www.safehose.com
 e-mail: indhose@parker.com

Series HY S113HY Male NPTF Pipe – Straight Swivel

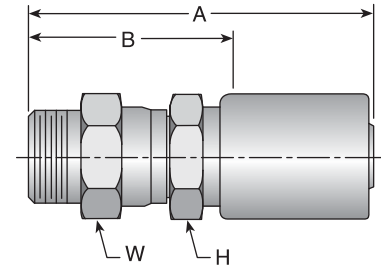

| Part Number | Hose ID (in) | Thread ID (in) | Thread Dash Size | Dimensions | | | | | | Std Pack Qty (per carton) | Approx Wt Per Ctn (lbs) | Stock Status ** |
|--------------|--------------|----------------|------------------|------------|--------|--------|--------|--------|--------|---------------------------|-------------------------|-----------------|
| | | | | A (in) | A (mm) | H (in) | W (in) | B (in) | B (mm) | | | |
| S113HY-4-4 | 1/4 | 1/4x18 | -4 | 3.06 | 78 | 9/16 | 5/8 | 1.72 | 44 | 25 | 2.95 | Y |
| S113HY-6-6 | 3/8 | 3/8x18 | -6 | 3.11 | 79 | 11/16 | 11/16 | 1.75 | 44 | 25 | 6.23 | Y |
| S113HY-8-8 | 1/2 | 1/2x14 | -8 | 3.50 | 89 | 7/8 | 7/8 | 2.16 | 55 | 25 | 8.55 | Y |
| S113HY-12-12 | 3/4 | 3/4x14 | -12 | 3.95 | 100 | 1-1/4 | 1-1/4 | 2.38 | 60 | 10 | 7.50 | Y |
| S113HY-16-16 | 1 | 1x11-1/2 | -16 | 4.23 | 107 | 1-1/2 | 1-1/2 | 2.63 | 67 | 10 | 11.52 | Y |

** Stock: "Y" indicates stocked item; "N" indicates non-stocked item. Stock status subject to change. Contact Parker Customer Service.

Series HY S139HY Female JIC 37° – 90° Swivel Short Drop Elbow

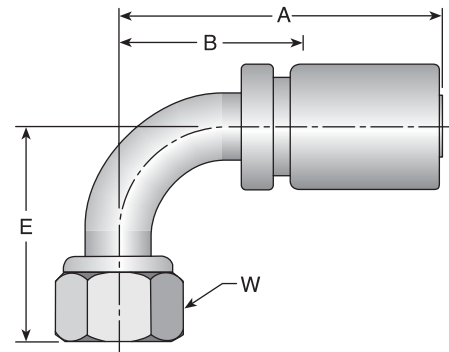

| Part Number | Hose ID (in) | Thread ID (in) | Thread Dash Size | Dimensions | | | | | | Std Pack Qty (per carton) | Approx Wt Per Ctn (lbs) | Stock Status ** | |
|--------------|--------------|----------------|------------------|------------|--------|--------|--------|--------|--------|---------------------------|-------------------------|-----------------|--------|
| | | | | A (in) | A (mm) | E (in) | E (mm) | W (in) | B (in) | | | | B (mm) |
| S139HY-4-4 | 1/4 | 7/16x20 | -4 | 2.40 | 61 | 0.83 | 21 | 9/16 | 1.13 | 29 | 10 | 1.47 | Y |
| S139HY-6-4 | 1/4 | 9/16x18 | -6 | 2.65 | 67 | 0.91 | 23 | 3/4 | 1.38 | 35 | 10 | 1.63 | Y |
| S139HY-6-6 | 3/8 | 9/16x18 | -6 | 2.57 | 65 | 0.91 | 23 | 11/16 | 1.29 | 33 | 10 | 2.17 | Y |
| S139HY-8-6 | 3/8 | 3/4x16 | -8 | 2.64 | 67 | 1.14 | 29 | 7/8 | 1.37 | 35 | 10 | 2.70 | Y |
| S139HY-8-8 | 1/2 | 3/4x16 | -8 | 2.85 | 72 | 1.14 | 29 | 7/8 | 1.56 | 40 | 10 | 3.60 | Y |
| S139HY-10-8 | 1/2 | 7/8x14 | -10 | 3.01 | 76 | 1.26 | 32 | 1 | 1.72 | 44 | 10 | 3.72 | Y |
| S139HY-10-10 | 5/8 | 7/8x14 | -10 | 3.09 | 78 | 1.26 | 32 | 1 | 1.73 | 44 | 10 | 4.73 | N |
| S139HY-12-8 | 1/2 | 1-1/16x12 | -12 | 3.61 | 92 | 1.83 | 46 | 1-1/4 | 2.25 | 57 | 10 | 7.00 | N |
| S139HY-12-10 | 5/8 | 1-1/16x12 | -12 | 3.61 | 92 | 1.89 | 48 | 1-1/4 | 2.25 | 57 | 10 | 7.00 | N |
| S139HY-12-12 | 3/4 | 1-1/16x12 | -12 | 3.68 | 93 | 1.89 | 48 | 1-1/4 | 2.15 | 55 | 5 | 3.50 | Y |
| S139HY-16-12 | 3/4 | 1-5/16x12 | -16 | 4.33 | 110 | 2.14 | 54 | 1-1/2 | 2.78 | 71 | 5 | 4.30 | N |
| S139HY-16-16 | 1 | 1-5/16x12 | -16 | 4.31 | 109 | 2.31 | 59 | 1-1/2 | 2.69 | 68 | 5 | 4.78 | Y |

** Stock: "Y" indicates stocked item; "N" indicates non-stocked item. Stock status subject to change. Contact Parker Customer Service.

Couplings: Refer to CrimpSource at www.safehose.com for coupling recommendations and crimp specifications.



Series 43

S10143 Male NPTF Pipe – Straight Rigid

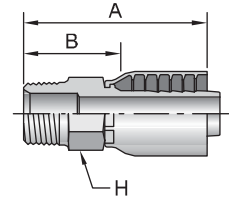

| Part Number | Hose ID (in) | Thread ID (in) | Thread Dash Size | Dimensions | | | | | Std Pack Qty (per carton) | Approx Wt Per Ctn (lbs) | Stock Status ** |
|--------------|--------------|----------------|------------------|------------|--------|--------|--------|--------|---------------------------|-------------------------|-----------------|
| | | | | A (in) | A (mm) | H (in) | B (in) | B (mm) | | | |
| S10143-4-4 | 1/4 | 1/4x18 | -4 | 2.01 | 51 | 9/16 | 1.26 | 32 | 25 | 3.00 | Y |
| S10143-6-6 | 3/8 | 3/8x18 | -6 | 2.37 | 60 | 3/4 | 1.34 | 34 | 25 | 4.25 | Y |
| S10143-8-8 | 1/2 | 1/2x14 | -8 | 2.84 | 72 | 7/8 | 1.58 | 40 | 20 | 5.30 | Y |
| S10143-12-12 | 3/4 | 3/4x14 | -12 | 3.09 | 78 | 1-1/16 | 1.65 | 42 | 10 | 4.35 | Y |
| S10143-16-16 | 1 | 1x11-1/2 | -16 | 2.59 | 66 | 1-3/8 | 1.97 | 50 | 5 | 3.71 | Y |
| S10143-20-20 | 1-1/4 | 1-1/4x11-1/2 | -20 | 4.08 | 104 | 1-3/4 | 2.39 | 61 | 5 | 5.50 | Y |
| S10143-24-24 | 1-1/2 | 1-1/2x11-1/2 | -24 | 3.50 | 89 | 2 | 2.13 | 54 | 5 | 8.06 | Y |
| S10143-32-32 | 2 | 2x11-1/2 | -32 | 4.05 | 103 | 2-1/2 | 2.27 | 58 | 5 | 13.37 | Y |

** Stock: "Y" indicates stocked item; "N" indicates non-stocked item. Stock status subject to change. Contact Parker Customer Service.

Series 43

S10643 Female JIC 37° – Straight Swivel

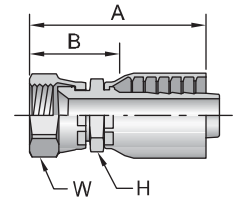

| Part Number | Hose ID (in) | Thread ID (in) | Thread Dash Size | Dimensions | | | | | Std Pack Qty (per carton) | Approx Wt Per Ctn (lbs) | Stock Status ** | |
|--------------|--------------|----------------|------------------|------------|--------|--------|--------|--------|---------------------------|-------------------------|-----------------|--------|
| | | | | A (in) | A (mm) | H (in) | W (in) | B (in) | | | | B (mm) |
| S10643-4-4 | 1/4 | 7/16x20 | -4 | 1.94 | 49 | 9/16 | 9/16 | 1.19 | 30 | 25 | 2.63 | Y |
| S10643-6-6 | 3/8 | 9/16x18 | -6 | 2.29 | 58 | 11/16 | 11/16 | 1.26 | 32 | 25 | 4.33 | Y |
| S10643-8-8 | 1/2 | 3/4x16 | -8 | 2.63 | 67 | 13/16 | 7/8 | 1.37 | 35 | 20 | 5.14 | Y |
| S10643-12-12 | 3/4 | 1-1/16x12 | -12 | 3.17 | 81 | 1-1/16 | 1-1/4 | 1.73 | 44 | 5 | 2.35 | Y |
| S10643-16-16 | 1 | 1-5/16x12 | -16 | 3.62 | 92 | 1-3/8 | 1-1/2 | 2.00 | 51 | 5 | 4.15 | Y |
| S10643-20-20 | 1-1/4 | 1-5/8x12 | -20 | 3.94 | 100 | 1-7/8 | 2 | 2.25 | 57 | 5 | 7.60 | Y |
| S10643-24-24 | 1-1/2 | 1-7/8x12 | -24 | 3.84 | 98 | 2-1/8 | 2-1/4 | 2.47 | 63 | 2 | 4.00 | Y |
| S10643-32-32 | 2 | 2-1/2x12 | -32 | 4.73 | 120 | 2-1/2 | 2-7/8 | 2.95 | 75 | 1 | 3.08 | Y |

** Stock: "Y" indicates stocked item; "N" indicates non-stocked item. Stock status subject to change. Contact Parker Customer Service.

Couplings: Refer to CrimpSource at www.safehose.com for coupling recommendations and crimp specifications.

Parker Industrial Hose Customer Service
 866 810 HOSE (4673) 800 242 HOSE (4673)
 Strongsville, OH South Gate, CA
 Eastern USA Western USA

www.safehose.com
 e-mail: indhose@parker.com

379



Series 43

S11343 Male NPTF Pipe – Straight Swivel

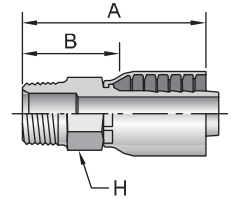

| Part Number | Hose ID (in) | Thread ID (in) | Thread Dash Size | Dimensions | | | | | Std Pack Qty (per carton) | Approx Wt Per Ctn (lbs) | Stock Status ** |
|-------------|--------------|----------------|------------------|------------|--------|--------|--------|--------|---------------------------|-------------------------|-----------------|
| | | | | A (in) | A (mm) | H (in) | B (in) | B (mm) | | | |
| S11343-4-4 | 1/4 | 1/4X18 | -4 | 2.68 | 68 | 5/8 | 1.93 | 49 | 10 | 1.53 | N |
| S11343-6-6 | 3/8 | 3/8X18 | -6 | 3.08 | 78 | 3/4 | 2.05 | 52 | 10 | 2.55 | Y |
| S11343-8-8 | 1/2 | 1/2X14 | -8 | 3.52 | 89 | 7/8 | 2.26 | 57 | 10 | 3.70 | Y |

** Stock: "Y" indicates stocked item; "N" indicates non-stocked item. Stock status subject to change. Contact Parker Customer Service.

Series 71

S10171 Male NPTF Pipe – Straight Rigid

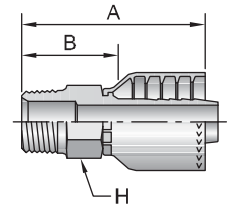

| Part Number | Hose ID (in) | Thread ID (in) | Thread Dash Size | Dimensions | | | | | Std Pack Qty (per carton) | Approx Wt Per Ctn (lbs) | Stock Status ** |
|--------------|--------------|----------------|------------------|------------|--------|--------|--------|--------|---------------------------|-------------------------|-----------------|
| | | | | A (in) | A (mm) | H (in) | B (in) | B (mm) | | | |
| S10171-20-20 | 1-1/4 | 1-1/4x11-1/2 | -20 | 4.06 | 103 | 1-3/4 | 2.39 | 61 | 2 | 2.50 | Y |
| S10171-24-24 | 1-1/2 | 1-1/2x11-1/2 | -24 | 4.32 | 110 | 2 | 2.19 | 56 | 1 | 2.02 | Y |
| S10171-32-32 | 2 | 2x11-1/2 | -32 | 4.66 | 118 | 2-1/2 | 2.52 | 64 | 2 | 6.45 | Y |

** Stock: "Y" indicates stocked item; "N" indicates non-stocked item. Stock status subject to change. Contact Parker Customer Service.

Series WC

S1APWC Male API – Straight Rigid

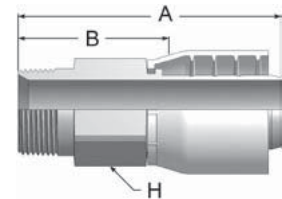

| Part Number | Hose ID (in) | Thread ID (in) | Thread Dash Size | Dimensions | | | | | Std Pack Qty (per carton) | Approx Wt Per Ctn (lbs) | Stock Status ** |
|--------------|--------------|----------------|------------------|------------|--------|--------|--------|--------|---------------------------|-------------------------|-----------------|
| | | | | A (in) | A (mm) | H (in) | B (in) | B (mm) | | | |
| S1APWC-32-32 | 2 | 2x11-1/2 | -32 | 7.17 | 182 | 2-5/8 | 3.92 | 99 | 2 | 2.00 | Y |

** Stock: "Y" indicates stocked item; "N" indicates non-stocked item. Stock status subject to change. Contact Parker Customer Service.

Couplings: Refer to CrimpSource at www.safehose.com for coupling recommendations and crimp specifications.



Series WC

S101WC Male NPTF Pipe – Straight Rigid

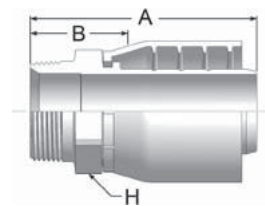

| Part Number | Hose ID (in) | Thread ID (in) | Thread Dash Size | Dimensions | | | | | | Std Pack Qty (per carton) | Approx Wt Per Ctn (lbs) | Stock Status ** |
|--------------|--------------|----------------|------------------|------------|--------|--------|--------|--------|---|---------------------------|-------------------------|-----------------|
| | | | | A (in) | A (mm) | H (in) | B (in) | B (mm) | | | | |
| S101WC-32-32 | 2 | 2x11-1/2 | -32 | 5.39 | 137 | 2-5/8 | 2.14 | 54 | 2 | 2.00 | Y | |

** Stock: "Y" indicates stocked item; "N" indicates non-stocked item. Stock status subject to change. Contact Parker Customer Service.

Series WC

S106WC Female JIC 37° – Straight Swivel

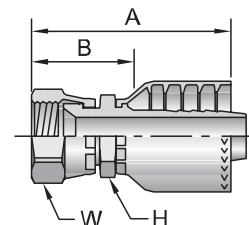

| Part Number | Hose ID (in) | Thread ID (in) | Thread Dash Size | Dimensions | | | | | | Std Pack Qty (per carton) | Approx Wt Per Ctn (lbs) | Stock Status ** |
|--------------|--------------|----------------|------------------|------------|--------|--------|--------|--------|--------|---------------------------|-------------------------|-----------------|
| | | | | A (in) | A (mm) | H (in) | W (in) | B (in) | B (mm) | | | |
| S106WC-32-32 | 2 | 2-1/2x12 | -32 | 5.95 | 151 | 2-5/8 | 2-7/8 | 2.70 | 69 | 2 | 2.00 | Y |

** Stock: "Y" indicates stocked item; "N" indicates non-stocked item. Stock status subject to change. Contact Parker Customer Service.

Series 7661/TY-FA

Female SAE 45° – Straight Swivel

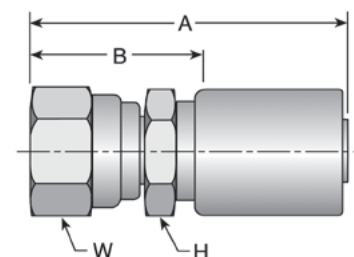

| Part Number | Hose ID (in) | Thread ID (in) | Thread Dash Size | Dimensions | | | | | | Std Pack Qty (per carton) | Approx Wt Per Ctn (lbs) | Stock Status ** |
|---------------|--------------|----------------|------------------|------------|--------|--------|--------|--------|--------|---------------------------|-------------------------|-----------------|
| | | | | A (in) | A (mm) | H (in) | W (in) | B (in) | B (mm) | | | |
| 7661-06FA04TY | 1/4 | 5/8x18 | -6 | 2.72 | 69 | 11/16 | 3/4 | 1.38 | 35 | 20 | 2.20 | Y |
| 7661-08FA08TY | 1/2 | 3/4x16 | -8 | 2.91 | 74 | 7/8 | 7/8 | 1.405 | 36 | 20 | 4.20 | N |
| 7661-10FA10TY | 5/8 | 7/8x14 | -10 | 3.06 | 78 | 1-1/8 | 1 | 1.69 | 43 | 20 | 6.20 | N |

** Stock: "Y" indicates stocked item; "N" indicates non-stocked item. Stock status subject to change. Contact Parker Customer Service.

Couplings: Refer to CrimpSource at www.safehose.com for coupling recommendations and crimp specifications.

Parker Industrial Hose Customer Service
 866 810 HOSE (4673) 800 242 HOSE (4673)
 Strongsville, OH South Gate, CA
 Eastern USA Western USA

www.safehose.com
 e-mail: indhose@parker.com

381



Series 7661/TY-FF Female NPTF Pipe – Straight Rigid

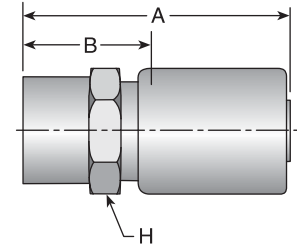

| Part Number | Hose ID (in) | Thread ID (in) | Thread Dash Size | Dimensions | | | | | Std Pack Qty (per carton) | Approx Wt Per Ctn (lbs) | Stock Status ** |
|---------------|--------------|----------------|------------------|------------|--------|--------|--------|--------|---------------------------|-------------------------|-----------------|
| | | | | A (in) | A (mm) | H (in) | B (in) | B (mm) | | | |
| 7661-04FF04TY | 1/4 | 1/4x18 | -4 | 2.47 | 63 | 11/16 | 1.15 | 26 | 25 | 3.23 | Y |

** Stock: "Y" indicates stocked item; "N" indicates non-stocked item. Stock status subject to change. Contact Parker Customer Service.

Series 7661/TY-FJ Female JIC 37° – Straight Swivel

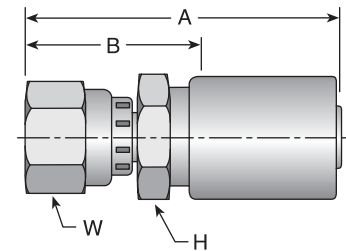

| Part Number | Hose ID (in) | Thread ID (in) | Thread Dash Size | Dimensions | | | | | | Std Pack Qty (per carton) | Approx Wt Per Ctn (lbs) | Stock Status ** |
|---------------|--------------|----------------|------------------|------------|--------|--------|--------|--------|--------|---------------------------|-------------------------|-----------------|
| | | | | A (in) | A (mm) | H (in) | W (in) | B (in) | B (mm) | | | |
| 7661-04FJ04TY | 1/4 | 7/16x20 | -4 | 2.60 | 66 | 9/16 | 9/16 | 1.25 | 32 | 25 | 3.18 | Y |
| 7661-08FJ08TY | 1/2 | 3/4x16 | -8 | 2.90 | 74 | 7/8 | 7/8 | 1.56 | 40 | 25 | 6.60 | Y |
| 7661-10FJ08TY | 1/2 | 7/8x14 | -10 | 2.98 | 76 | 1 | 1 | 1.63 | 41 | 20 | 5.28 | Y |

** Stock: "Y" indicates stocked item; "N" indicates non-stocked item. Stock status subject to change. Contact Parker Customer Service.

Series 7661/TY-MP Male NPTF Pipe – Straight Rigid

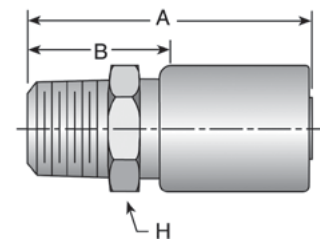

| Part Number | Hose ID (in) | Thread ID (in) | Thread Dash Size | Dimensions | | | | | Std Pack Qty (per carton) | Approx Wt Per Ctn (lbs) | Stock Status ** |
|---------------|--------------|----------------|------------------|------------|--------|--------|--------|--------|---------------------------|-------------------------|-----------------|
| | | | | A (in) | A (mm) | H (in) | B (in) | B (mm) | | | |
| 7661-04MP04TY | 1/4 | 1/4x18 | -4 | 2.53 | 64 | 9/16 | 1.19 | 30 | 50 | 7.00 | Y |
| 7661-06MP08TY | 1/2 | 3/8x18 | -6 | 2.72 | 69 | 7/8 | 1.38 | 35 | 20 | 6.00 | N |
| 7661-08MP08TY | 1/2 | 1/2x14 | -8 | 2.91 | 74 | 7/8 | 1.56 | 40 | 50 | 15.00 | Y |
| 7661-12MP08TY | 1/2 | 3/4x14 | -12 | 2.91 | 74 | 1-1/16 | 1.56 | 40 | 20 | 6.00 | Y |

** Stock: "Y" indicates stocked item; "N" indicates non-stocked item. Stock status subject to change. Contact Parker Customer Service.

Couplings: Refer to CrimpSource at www.safehose.com for coupling recommendations and crimp specifications.



Series 7661/TY-SP Male NPTF Pipe – Straight Swivel

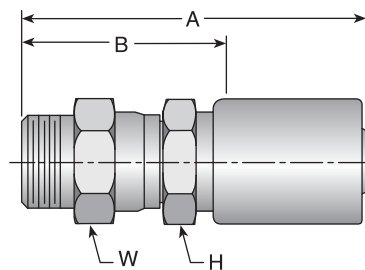

| Part Number | Hose ID (in) | Thread ID (in) | Thread Dash Size | Dimensions | | | | | | Std Pack Qty (per carton) | Approx Wt Per Ctn (lbs) | Stock Status ** |
|---------------|--------------|----------------|------------------|------------|--------|--------|--------|--------|--------|---------------------------|-------------------------|-----------------|
| | | | | A (in) | A (mm) | H (in) | W (in) | B (in) | B (mm) | | | |
| 7661-08SP08TY | 1/2 | 1/2x14 | -8 | 3.50 | 89 | 7/8 | 7/8 | 2.16 | 55 | 25 | 8.55 | Y |

** Stock: "Y" indicates stocked item; "N" indicates non-stocked item. Stock status subject to change. Contact Parker Customer Service.

Series 7661/LA-FJ Female JIC 37° – Straight Swivel

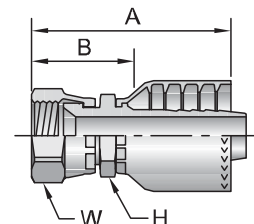

| Part Number | Hose ID (in) | Thread ID (in) | Thread Dash Size | Dimensions | | | | | | Std Pack Qty (per carton) | Approx Wt Per Ctn (lbs) | Stock Status ** |
|---------------|--------------|----------------|------------------|------------|--------|--------|--------|--------|--------|---------------------------|-------------------------|-----------------|
| | | | | A (in) | A (mm) | H (in) | W (in) | B (in) | B (mm) | | | |
| 7661-32FJ32LA | 2 | 2-1/2x12 | -32 | 5.39 | 137 | 2-5/8 | 2-7/8 | 2.70 | 69 | 7 | 27.20 | Y |

** Stock: "Y" indicates stocked item; "N" indicates non-stocked item. Stock status subject to change. Contact Parker Customer Service.

Series 7661/LA-NP Male NPTF Pipe – Straight Rigid

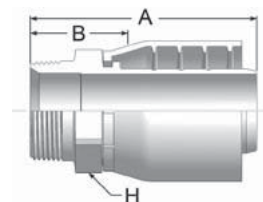

| Part Number | Hose ID (in) | Thread ID (in) | Thread Dash Size | Dimensions | | | | | | Std Pack Qty (per carton) | Approx Wt Per Ctn (lbs) | Stock Status ** |
|---------------|--------------|----------------|------------------|------------|--------|--------|--------|--------|---|---------------------------|-------------------------|-----------------|
| | | | | A (in) | A (mm) | H (in) | B (in) | B (mm) | | | | |
| 7661-32NP32LA | 2 | 2x11-1/2 | -32 | 5.39 | 137 | 2-5/8 | 2.14 | 54 | 8 | 26.90 | Y | |

** Stock: "Y" indicates stocked item; "N" indicates non-stocked item. Stock status subject to change. Contact Parker Customer Service.

Couplings: Refer to CrimpSource at www.safehose.com for coupling recommendations and crimp specifications.

Parker Industrial Hose Customer Service
866 810 HOSE (4673) 800 242 HOSE (4673)
Strongsville, OH South Gate, CA
Eastern USA Western USA

www.safehose.com
e-mail: indhose@parker.com

383



Series 7661/LAR-FJ Female JIC 37° – Straight Swivel with Internal O-Ring

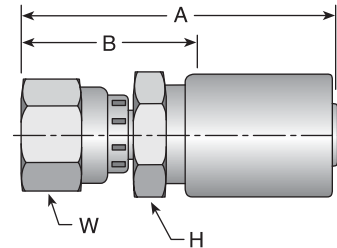

| Part Number | Hose ID (in) | Thread ID (in) | Thread Dash Size | Dimensions | | | | | | Std Pack Qty (per carton) | Approx Wt Per Ctn (lbs) | Stock Status ** |
|----------------|--------------|----------------|------------------|------------|--------|--------|--------|--------|--------|---------------------------|-------------------------|-----------------|
| | | | | A (in) | A (mm) | H (in) | W (in) | B (in) | B (mm) | | | |
| 7661-16FJ16LAR | 1 | 1-5/16x12 | -16 | 3.55 | 90 | 1-3/8 | 1-3/8 | 1.81 | 46 | 25 | 17.15 | Y |

** Stock: "Y" indicates stocked item; "N" indicates non-stocked item. Stock status subject to change. Contact Parker Customer Service.

Series 7661/LAR-MP Male NPTF Pipe – Straight Rigid with Internal O-Ring

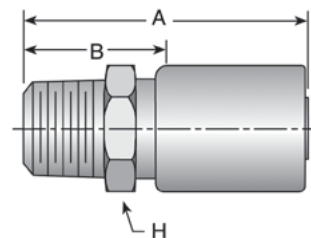

| Part Number | Hose ID (in) | Thread ID (in) | Thread Dash Size | Dimensions | | | | | Std Pack Qty (per carton) | Approx Wt Per Ctn (lbs) | Stock Status ** |
|----------------|--------------|----------------|------------------|------------|--------|--------|--------|--------|---------------------------|-------------------------|-----------------|
| | | | | A (in) | A (mm) | H (in) | B (in) | B (mm) | | | |
| 7661-16MP16LAR | 1 | 1x11-1/2 | -16 | 3.42 | 87 | 1-3/8 | 1.69 | 43 | 25 | 15.73 | Y |

** Stock: "Y" indicates stocked item; "N" indicates non-stocked item. Stock status subject to change. Contact Parker Customer Service.

Series CS S101CS Male NPTF Pipe – Straight Rigid

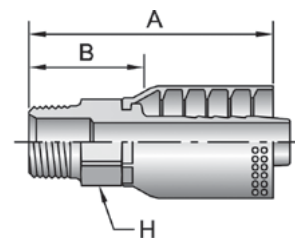

| Part Number | Hose ID (in) | Thread ID (in) | Thread Dash Size | Dimensions | | | | | Std Pack Qty (per carton) | Approx Wt Per Ctn (lbs) | Stock Status ** |
|--------------|--------------|----------------|------------------|------------|--------|--------|--------|--------|---------------------------|-------------------------|-----------------|
| | | | | A (in) | A (mm) | H (in) | B (in) | B (mm) | | | |
| S101CS-12-12 | 3/4 | 3/4x14 | -12 | 3.56 | 90 | 1-1/8 | 1.75 | 44 | 25 | 16.05 | Y |
| S101CS-16-16 | 1 | 1x11-1/2 | -16 | 3.94 | 100 | 1-3/8 | 2.00 | 51 | 25 | 27.43 | Y |

** Stock: "Y" indicates stocked item; "N" indicates non-stocked item. Stock status subject to change. Contact Parker Customer Service.

Couplings: Refer to CrimpSource at www.safehose.com for coupling recommendations and crimp specifications.



Series 7610/CS Crimp Coupling for Steam Hose Female Ground Joint NPSM with Wing Nut and O-Ring

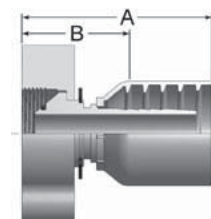

| Part Number | Description | Hose ID (in) | Thread (in) | Dimensions | | | | Std Pack Qty (per carton) | Approx Wt Per Each (lbs) | Stock Status ** |
|---------------|---------------|--------------|-------------|------------|--------|--------|--------|---------------------------|--------------------------|-----------------|
| | | | | A (in) | A (mm) | B (in) | B (mm) | | | |
| 7610-12CSGJF | With Wing Nut | 3/4 | 1-1/2 | 3.70 | 94 | 1.57 | 40 | Per Order | 1.00 | Y |
| 7610-12CSGJFS | Spud | 3/4 | 1-1/2 | n/a | n/a | n/a | n/a | Per Order | 1.00 | Y |
| 7610-16CSGJF | With Wing Nut | 1 | 1-1/2 | 3.97 | 100 | 1.53 | 39 | Per Order | 1.00 | Y |

** Stock: "Y" indicates stocked item; "N" indicates non-stocked item. Stock status subject to change. Contact Parker Customer Service.

Series 7612 Spud Adapter for Steam Hose

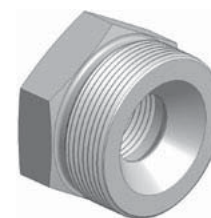

| Part Number | Description | Std Pack Qty (per carton) | Approx Wt Per Ctn (lbs) | Stock Status ** |
|--------------|---|---------------------------|-------------------------|-----------------|
| 7612-750GFS3 | 3/4" Female Pipe Straight to 1-1/2" Ground Joint Male | 10 | 10.00 | Y |

** Stock: "Y" indicates stocked item; "N" indicates non-stocked item. Stock status subject to change. Contact Parker Customer Service.

Series 20 Reattachable Couplings for LPG Fuel Hose Female SAE 45° – Straight Swivel

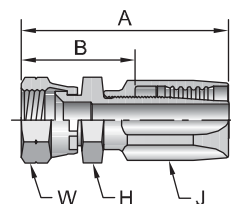

| Part Number | Hose ID (in) | Thread ID (in) | Thread Dash Size | Dimensions | | | | | | | Std Pack Qty (per carton) | Approx Wt Per Ctn (lbs) | Stock Status ** |
|-------------|--------------|----------------|------------------|------------|--------|--------|--------|--------|--------|--------|---------------------------|-------------------------|-----------------|
| | | | | A (in) | A (mm) | H (in) | J (in) | W (in) | B (in) | B (mm) | | | |
| S20820-6-6 | 5/16 | 5/8x18 | -6 | 2.36 | 60 | 3/4 | 13/16 | 3/4 | 1.44 | 37 | 25 | 4.20 | Y |

** Stock: "Y" indicates stocked item; "N" indicates non-stocked item. Stock status subject to change. Contact Parker Customer Service.

Series CGHBL Brass Stem for Welding Hose NOTE: Use D Nuts

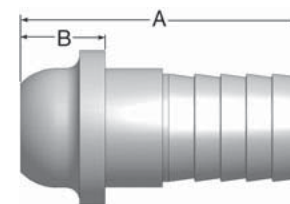

| Part Number | Hose ID (in) | Dimensions | | | | Std Pack Qty (per carton) | Approx Wt Per Each (lbs) | Stock Status ** |
|-------------|--------------|------------|--------|--------|--------|---------------------------|--------------------------|-----------------|
| | | A (in) | A (mm) | B (in) | B (mm) | | | |
| CGHBL-12-12 | 3/4 | 2.26 | 57 | 0.62 | 16 | Per Order | 0.50 | Y |

** Stock: "Y" indicates stocked item; "N" indicates non-stocked item. Stock status subject to change. Contact Parker Customer Service.

Couplings: Refer to CrimpSource at www.safehose.com for coupling recommendations and crimp specifications.

Parker Industrial Hose Customer Service
866 810 HOSE (4673) 800 242 HOSE (4673)
Strongsville, OH South Gate, CA
Eastern USA Western USA

www.safehose.com
e-mail: indhose@parker.com

385

